

- 20** : 2.0 L 车型
- OP** : 不需要按钮启动
- WP** : 需按钮启动
- NM** : 常规仪表
- LM** : 发光仪表

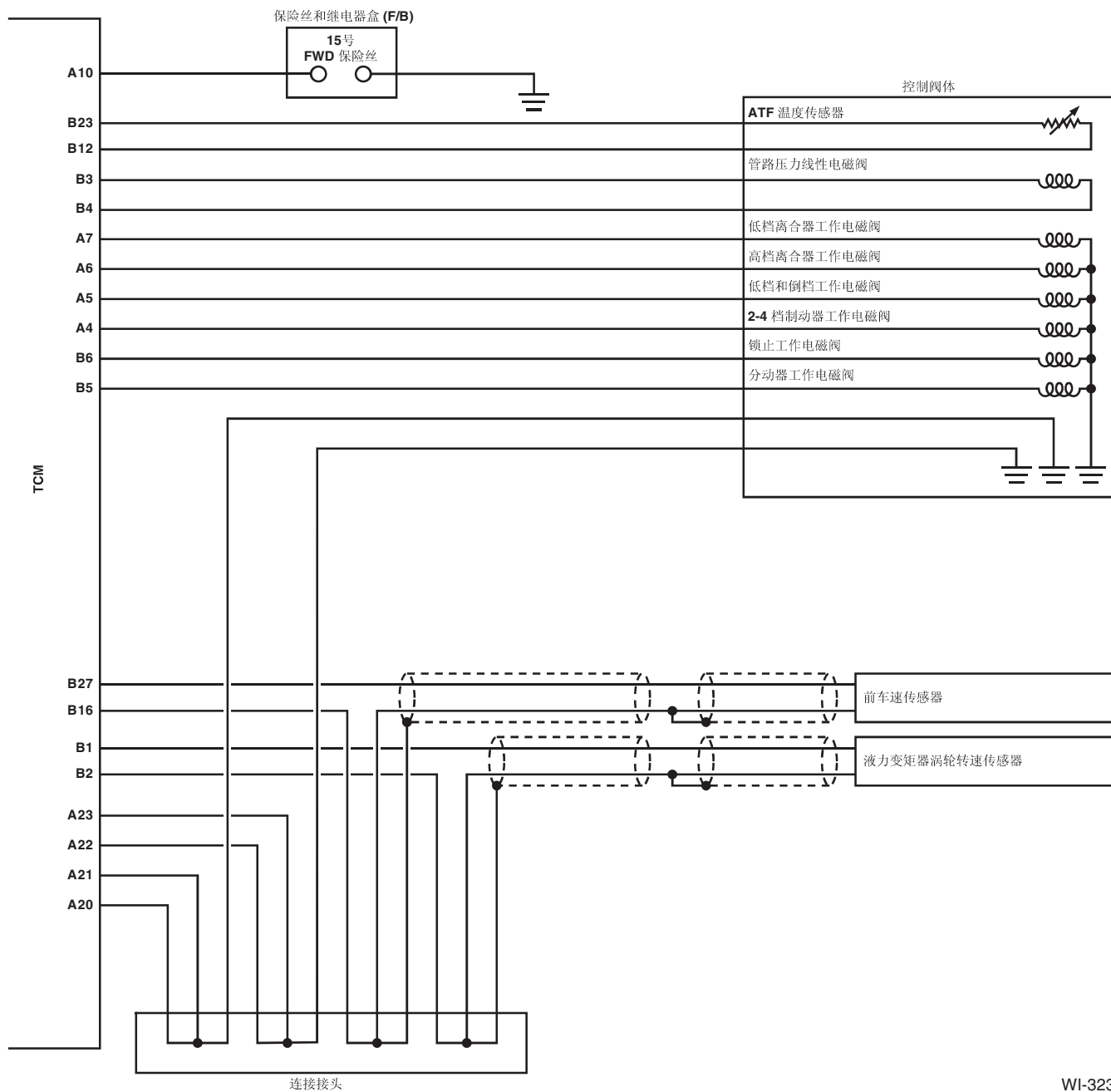

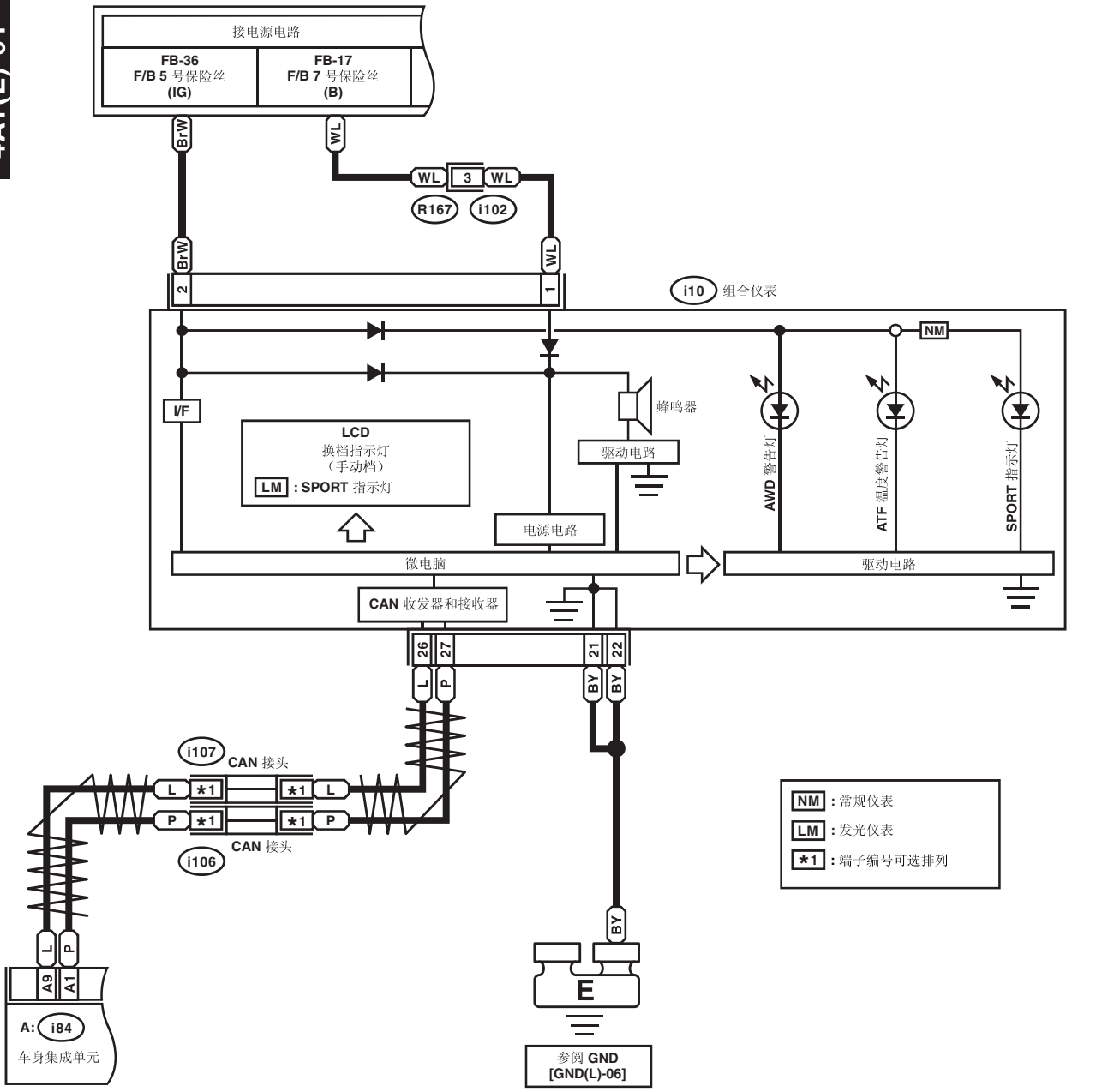

NM : 常规仪表
LM : 发光仪表
*1 : 端子编号可选排列

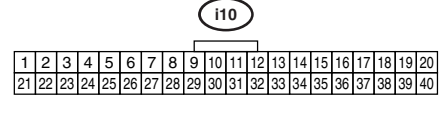
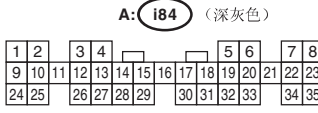
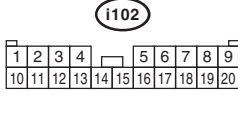
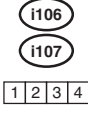

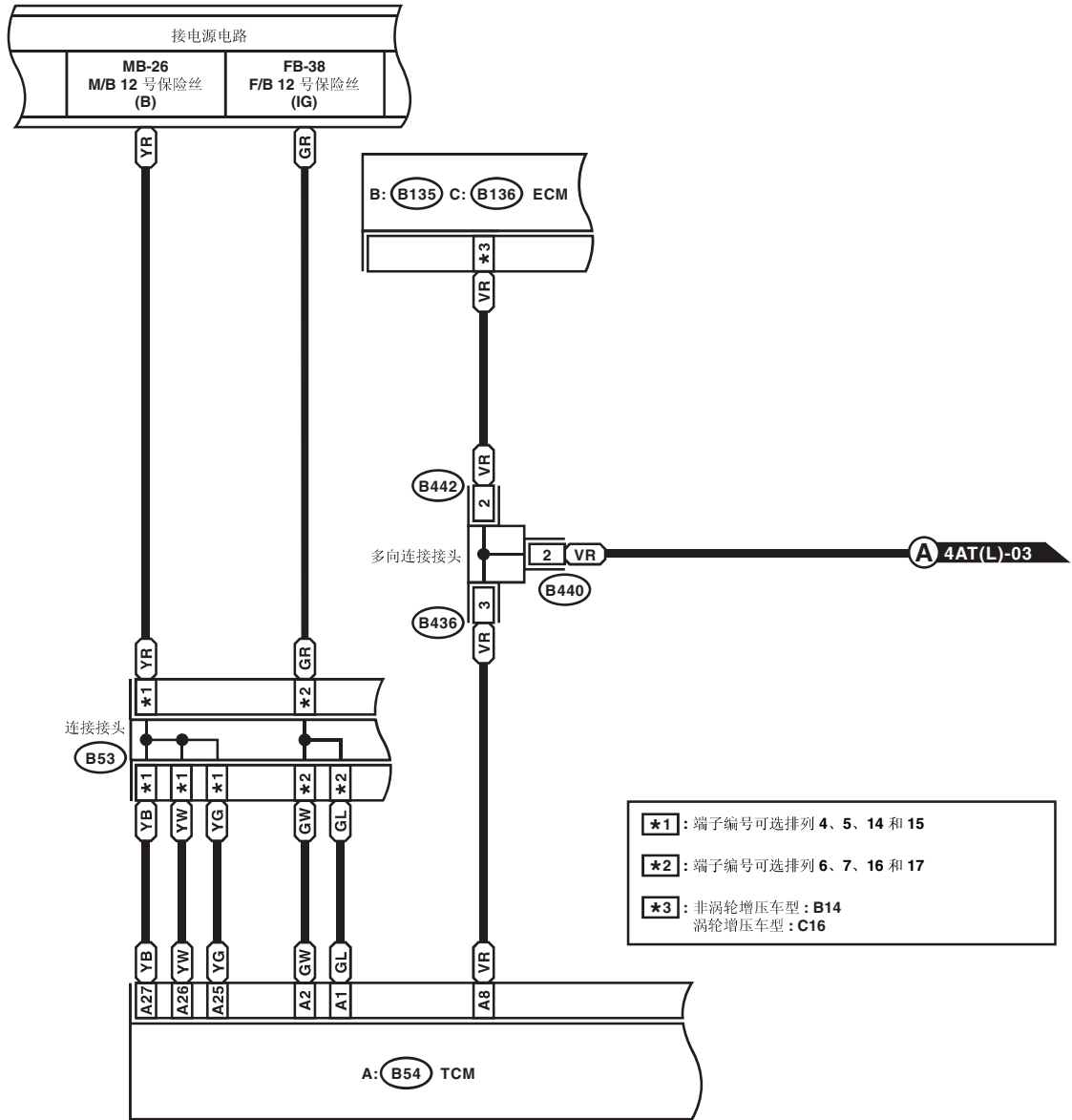

(黄色) B436 B442 (黑色)

(橙色) B440

1	2	3	4	5
---	---	---	---	---

B53

1	2	3	4	5	6	7	8	9	10
11	12	13	14	15	16	17	18	19	20

A: B54

B: B135

1	2	3	4	5	6	7
8	9	10	11	12	13	14
15	16	17	18	19	20	21
22	23	24	25	26	27	28
29	30	31	32	33	34	35

C: B136

1	2	3	4	5	6
7	8	9	10	11	12
13	14	15	16	17	18
19	20	21	22	23	24
25	26	27	28	29	30
31	32	33	34	35	

5AT(L)-03

5AT(L)-03

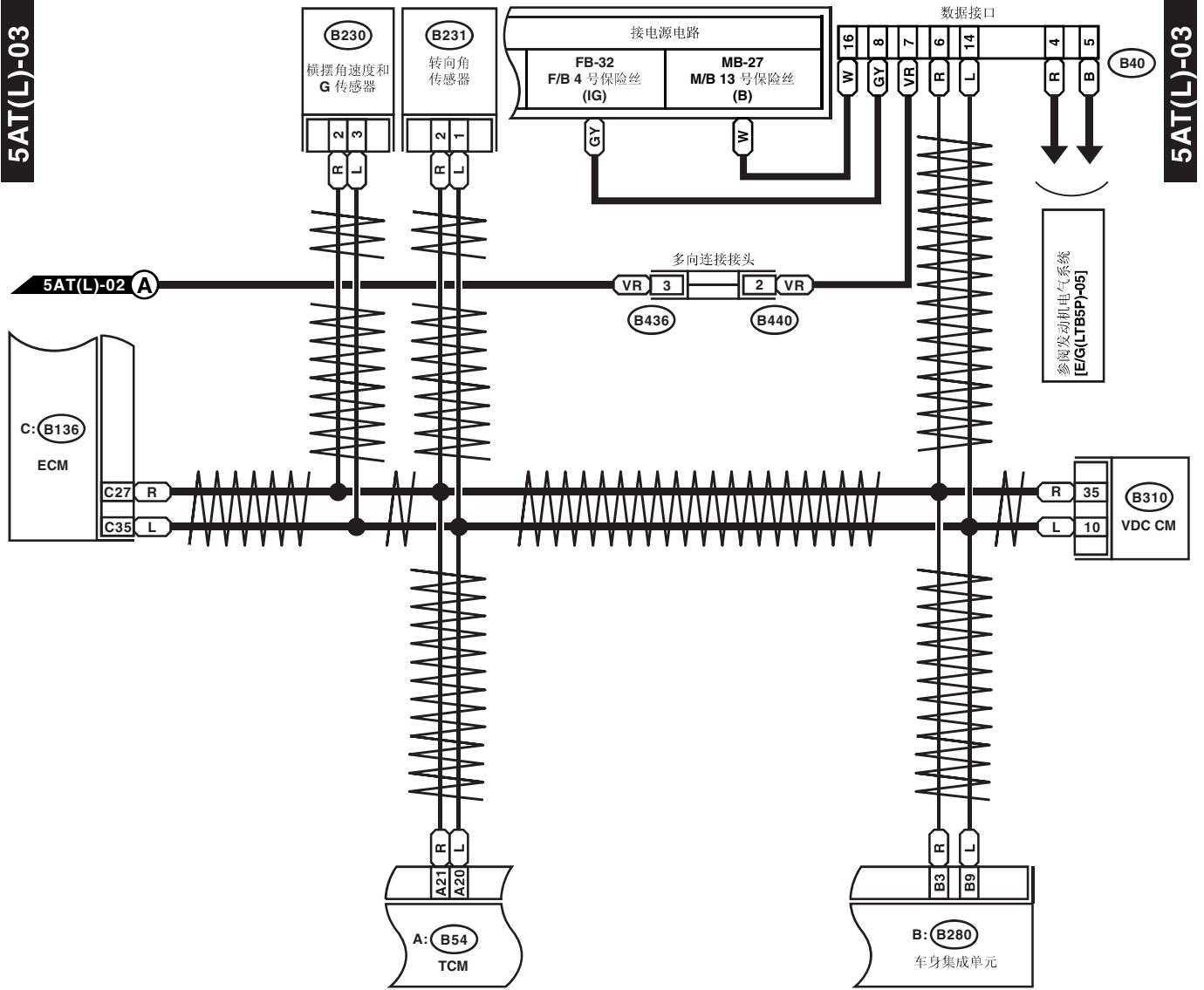

B230 (黑色)

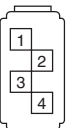

B231 (黑色)



B436 (黄色)

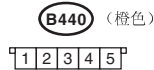

B440 (橙色)

B40 (黑色)

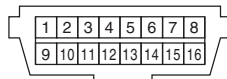

B: B280 (深灰色)



A: B54



C: B136



B310 (黑色)

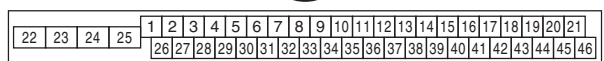

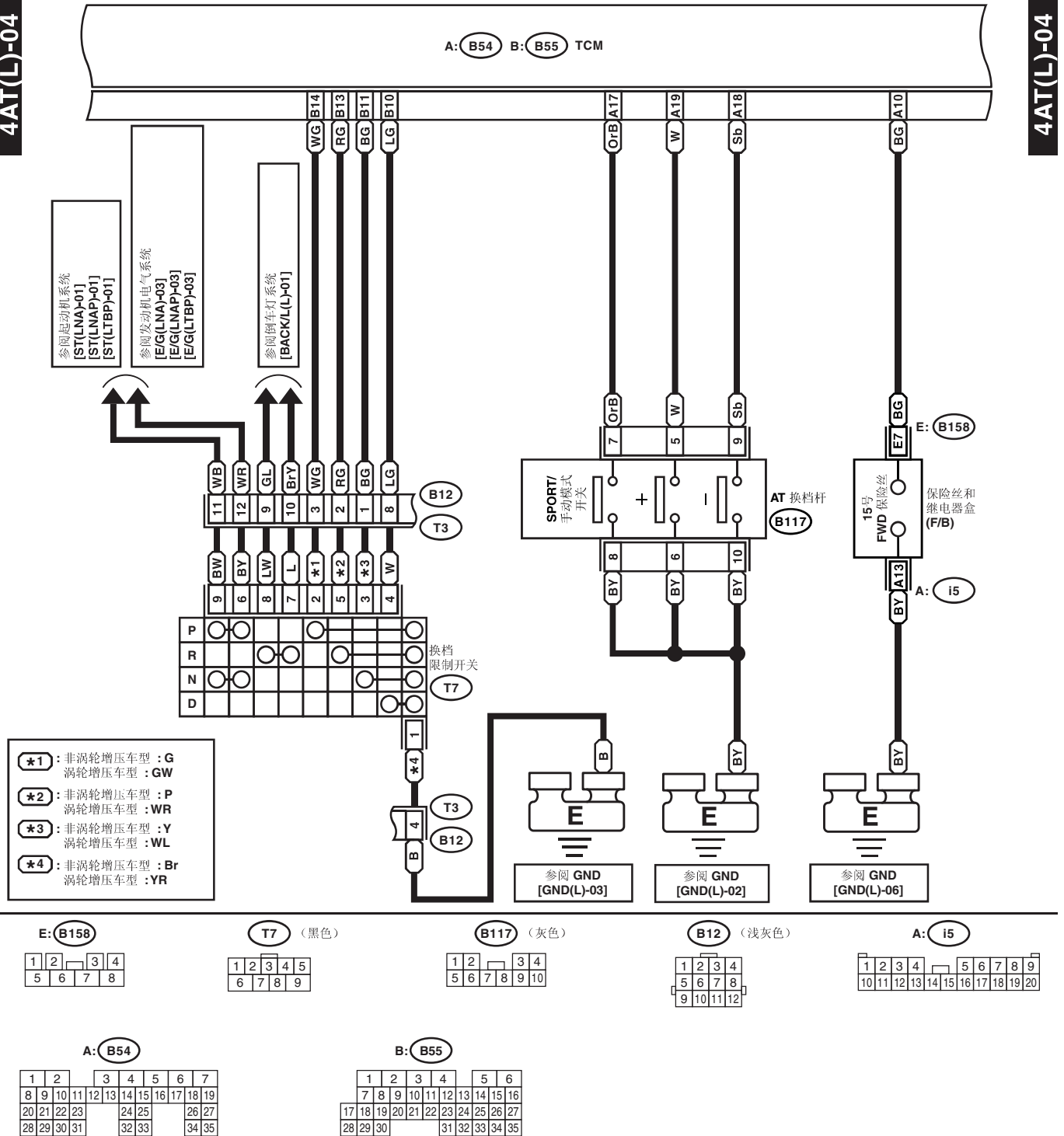

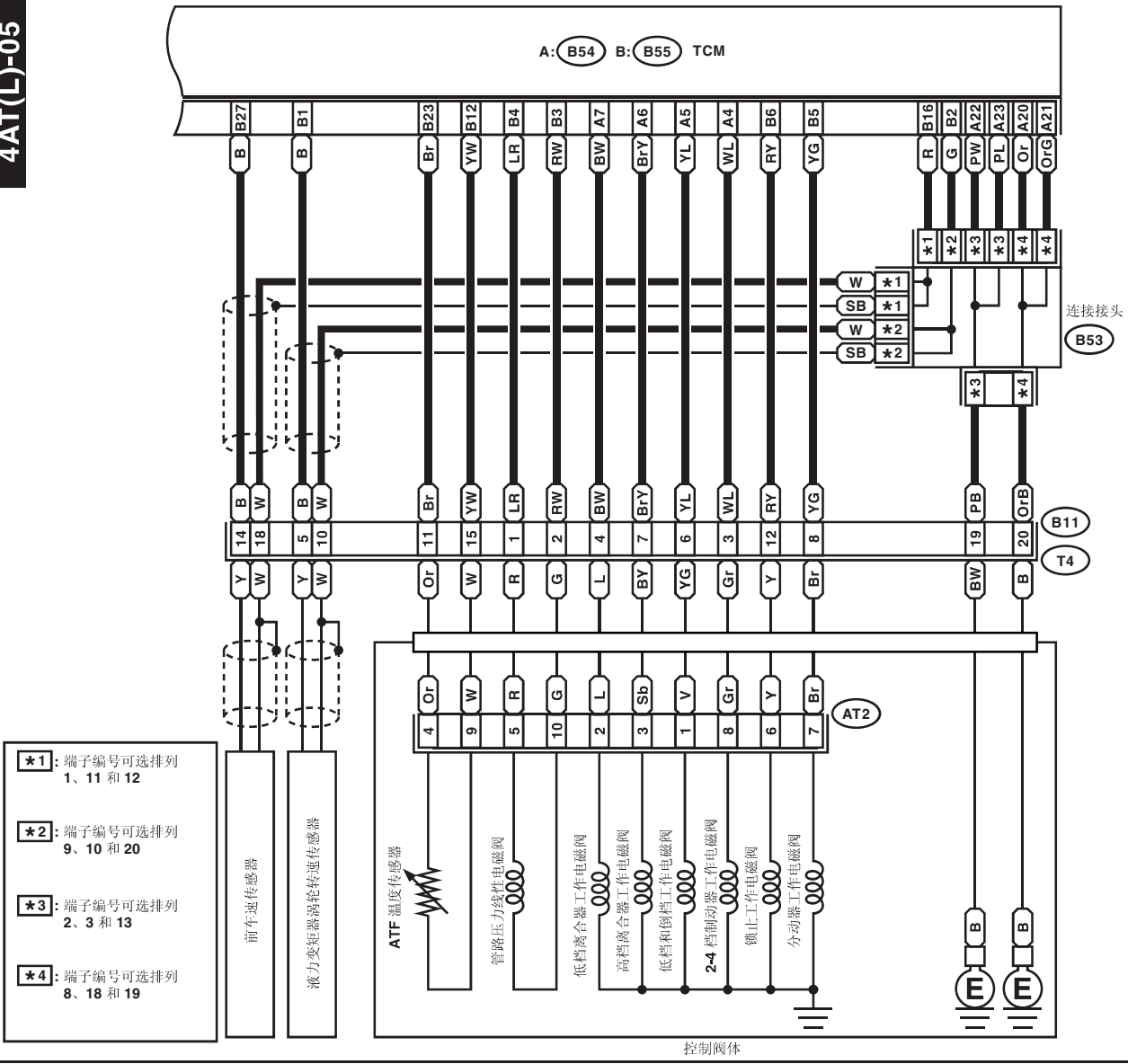

- *1**: 端子编号可选排列 1、11 和 12
- *2**: 端子编号可选排列 9、10 和 20
- *3**: 端子编号可选排列 2、3 和 13
- *4**: 端子编号可选排列 8、18 和 19

